

Installation instructions for PZ4AL-02214-00

LEXUS GS 250; GS 250 F-sport; GS 450h

Under Run Protective Shield Engine Bay



Model Year:

GS 450h - 2012

GS 250 - 2012

Vehicle Code:

GWL10L-BEXQBW

GRL11L-BETQHW

Part Number:

PZ4AL-02214-00



Weight:

11.26 kg



InstallationTime:

30 min

Part number: PZ4AL-02214-00

A

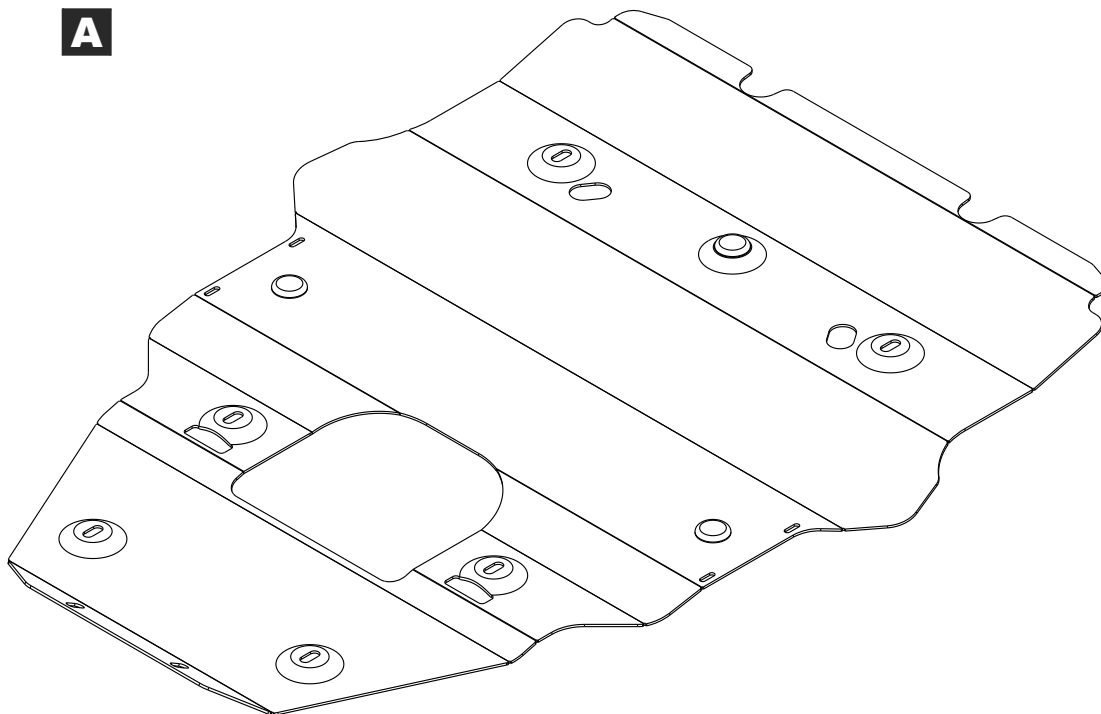

PZ4AL-02214-60

B

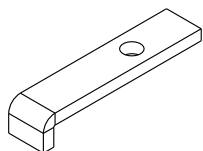

2x

C

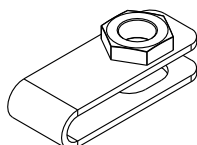

2x

D

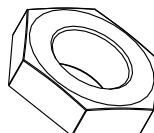

2x M10

E



6x M10X30

F1

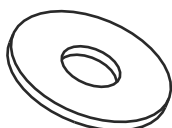

8x Ø10

F2

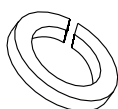

6x Ø10G

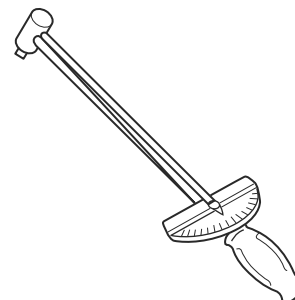
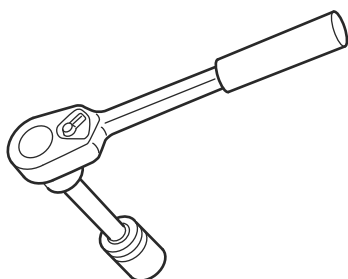

Part number:
PZ4AL-02214-00

Issue:
0

Date:
28/05/12

Page:
2/5

1

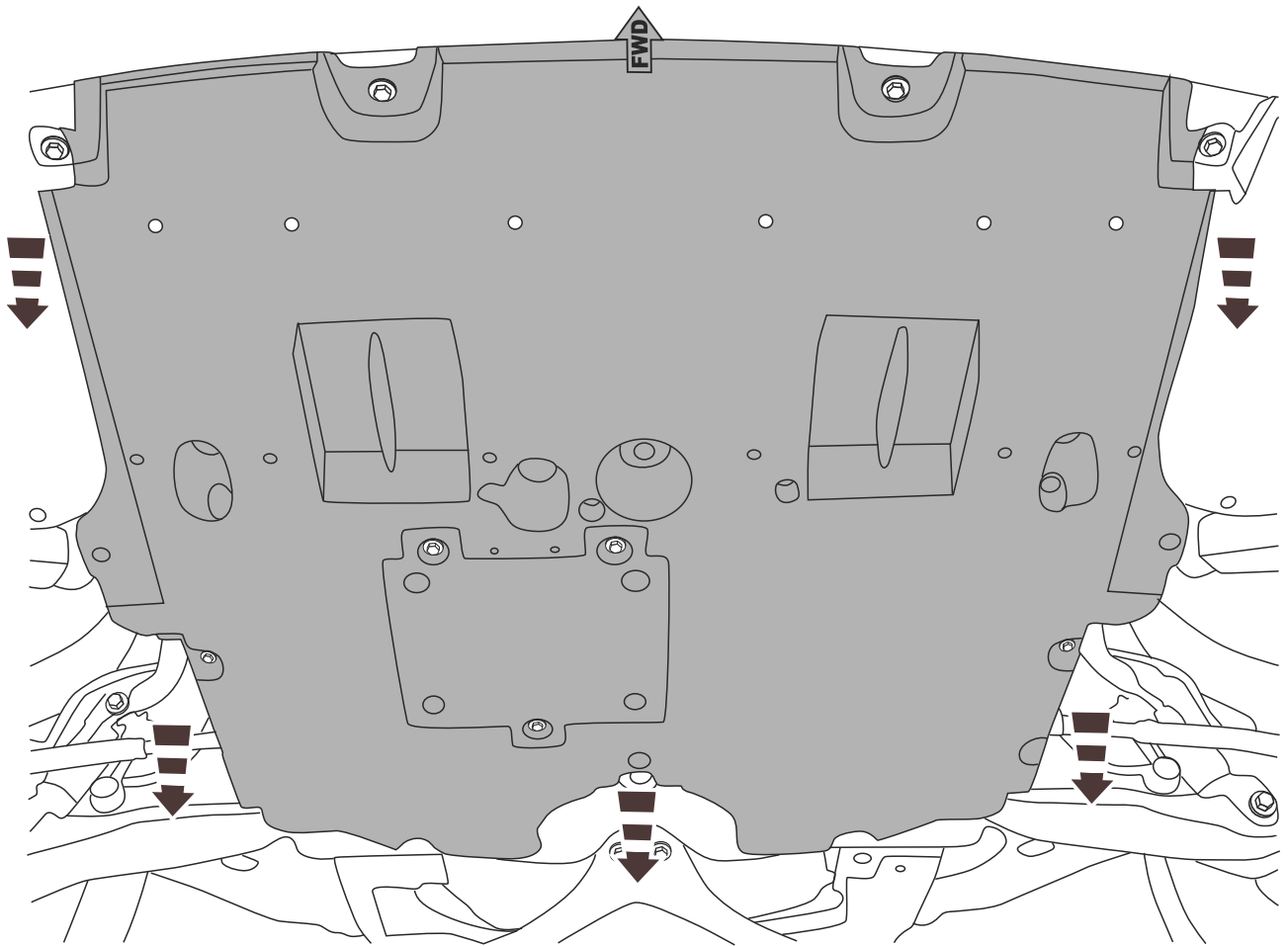

2

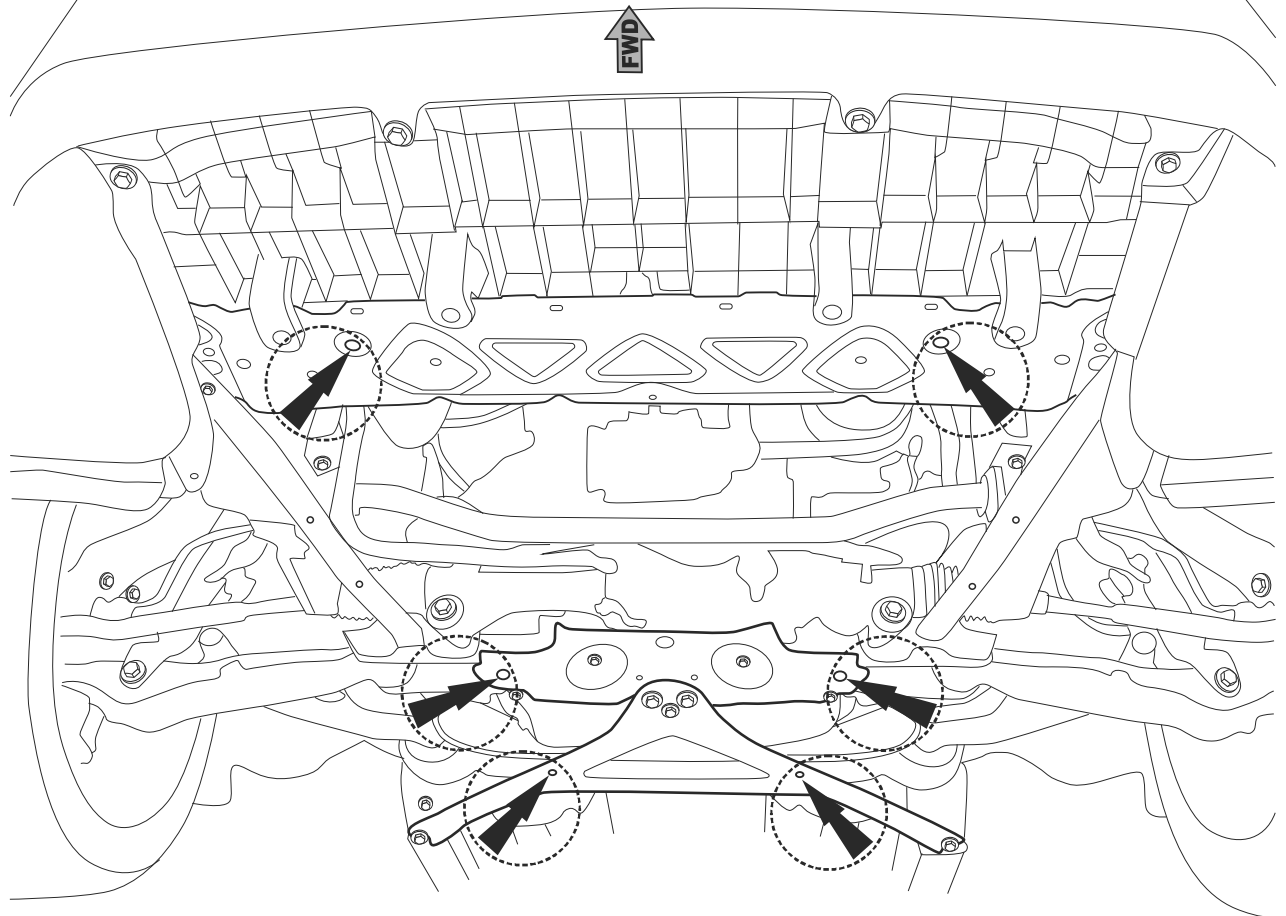

3

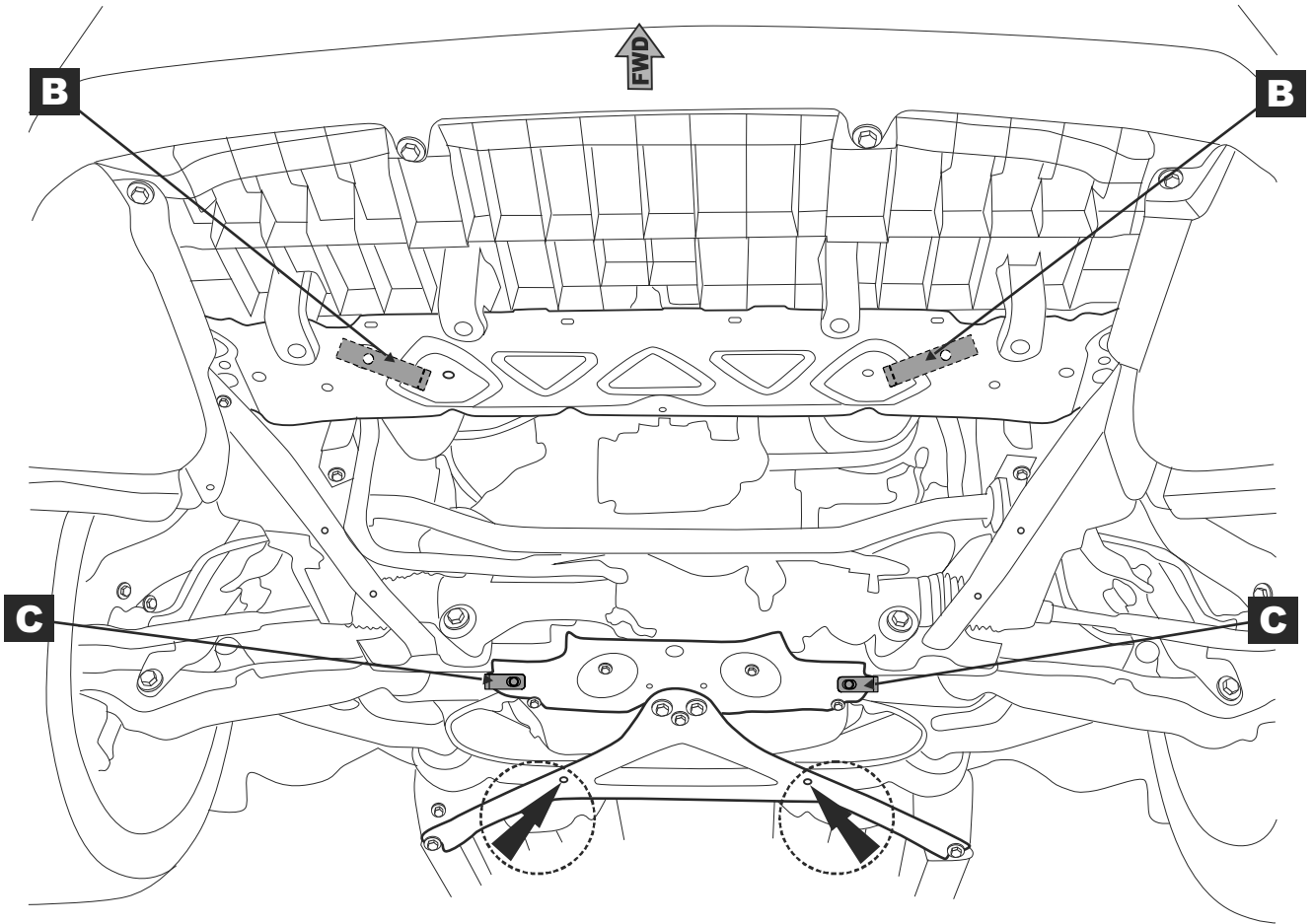

4

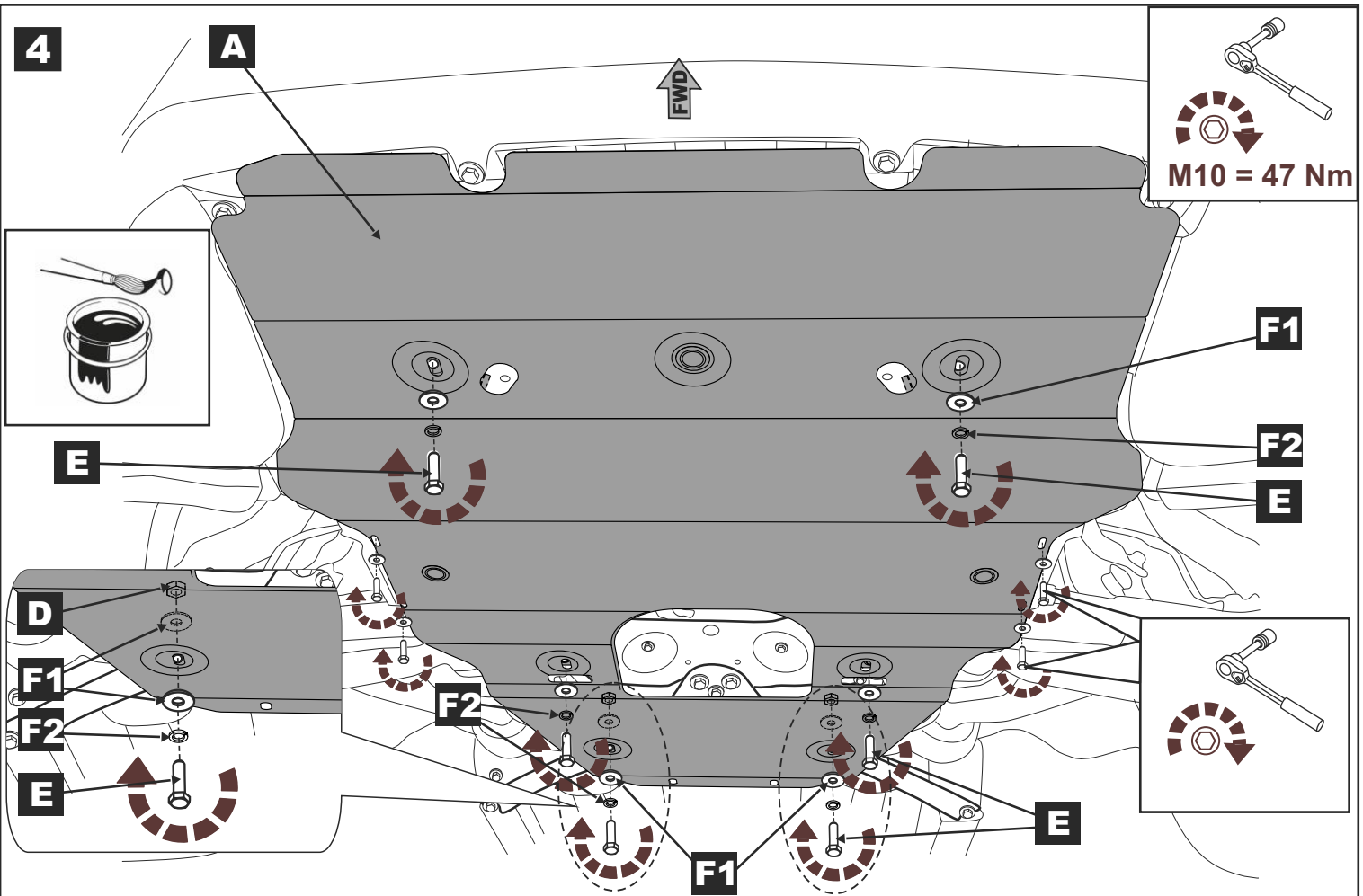

5

